

PSM952430

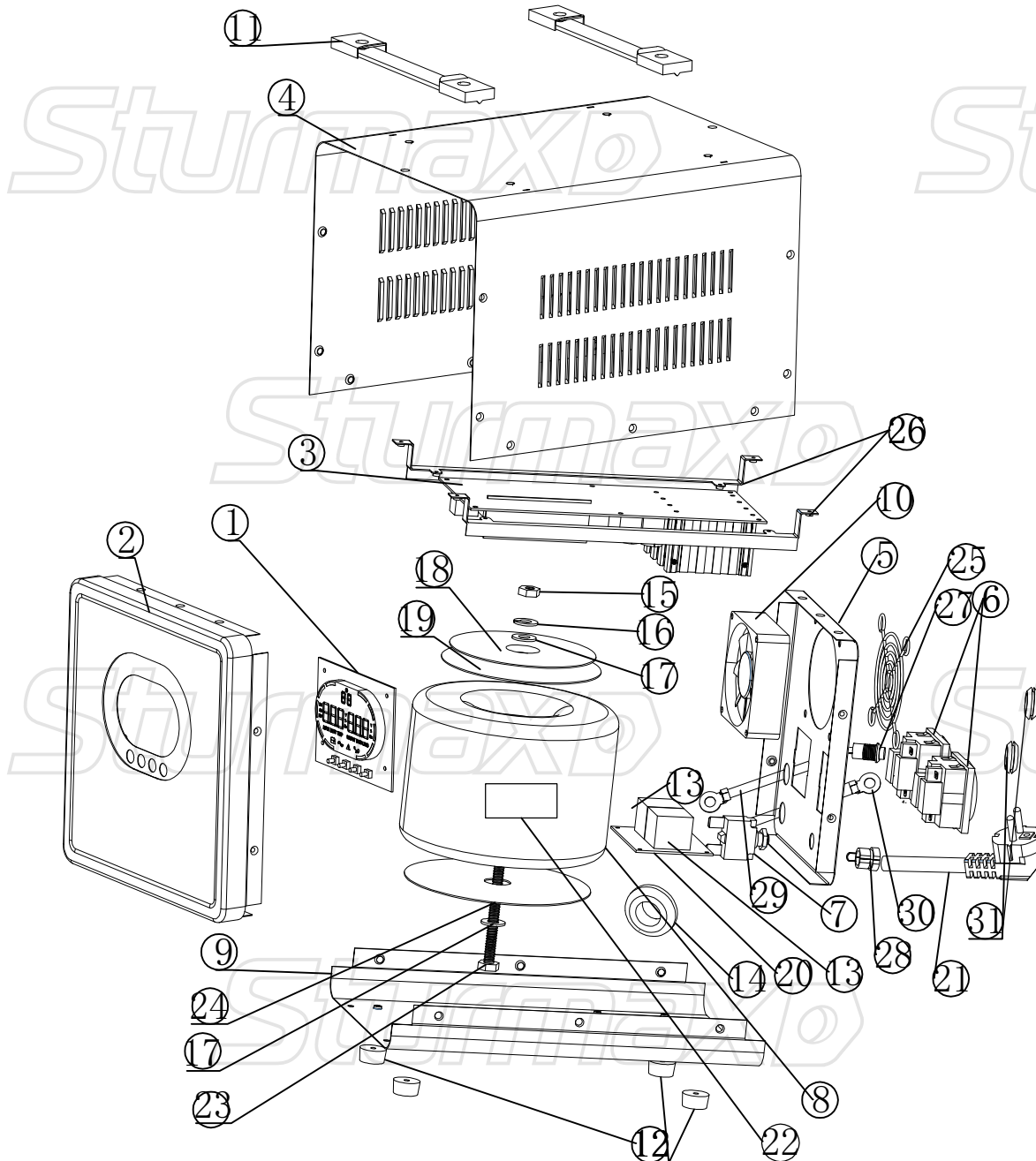

NO.	DESCRIPTION
1	LED DISPLAY PANEL
2	FRONT METAL PANEL
3	PCB
4	METAL COVER
5	BACK METAL PANEL
6	EU STANDARD SOCKET
7	OVECURRENT PROTECTOR
8	TOROIDAL TRANSFORMER
9	BASE METAL PANEL
10	FAN
11	HANDLE
12	FEET
13	RELAY WITH POLARITY PROTECTION
14	RELAY OF PCB
15	HEXAGON NUT
16	SPRING PAD
17	FLAT PAD
18	IRON COVER OF TRANSFORMER
19	SMALL RUBBER PAD
20	PCB FOR POLARITY PROTECTOR
21	POWER CABLE AND PLUG
22	TEMPERATURE CONTROLLER
23	SCREW ROD
24	BIG RUBBER PAD
25	COVER OF FAN
26	BRACKET
27	SILENT MODE BUTTON
28	WIRE CLIP
29	BATTERY WIRE NEGATIVE ELECTRODE/POLE
30	BATTERY WIRE POSITIVE ELECTRODE/POLE
31	PROTECTIVE COIL