

ДШ-3118П

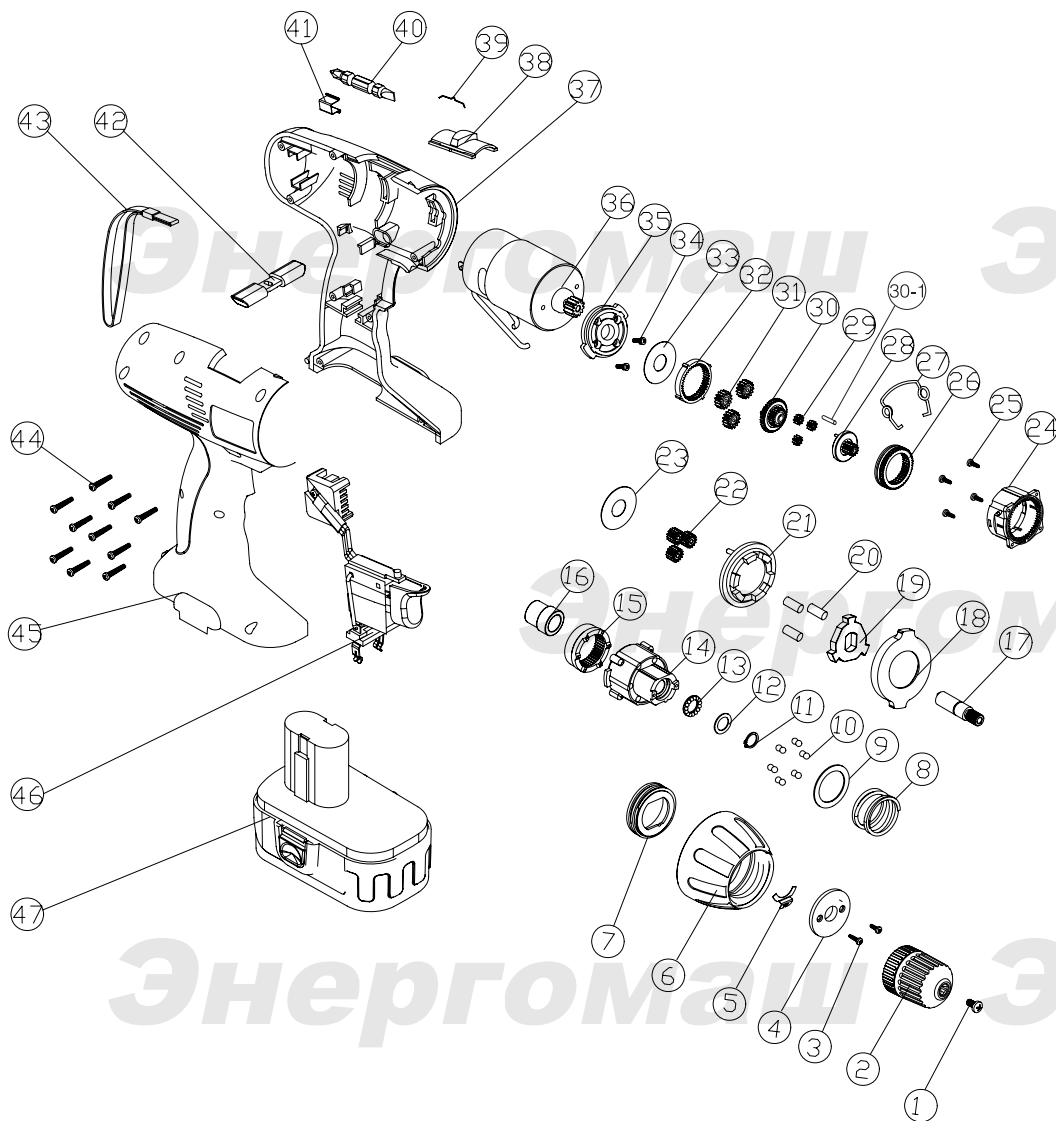

NO.	DESCRIPTION	NO.	DESCRIPTION
1	CHUCK SCREW	25	TAPPING SCREW
2	CHUCK	26	MOVABLE RING GEAR
3	SCREW	27	LEVER
4	COMPRESSING PLATE	28	PLANET CARRIER
5	SPRING	29	PLANET GEAR
6	TORQUE SETTING RING	30	PLANET CARRIER
7	INNER THREAD RING	30-1	PIN
8	TORQUE SPRING	31	PLANET GEAR
9	BIG WASHER	32	FIXED RING GEAR
10	BALL GROUP	33	WASHER
11	SNAP RING	34	TAPPING SCREW
12	WASHER	35	MOTOR FLANGE
13	SMALL BALL GROUP	36	MOTOR
14	GEARING BOX	37	ENCLOSURE
15	RING GEAR	38	TWO SPEED SWITCH
16	SHAFT COLLAR	39	SPRING
17	SHAFT	40	DRIVER BIT
18	IMMOBILE RING	41	BIT HOLDER
19	INITIATIVE TRAY	42	FWD/REV SWITCH
20	PIN	43	FASTENING STRINP
21	PLANET CARRIER	44	SCREW
22	PLANET GEAR	45	ENCLOSURE
23	WASHER	46	ON/OFF SWITCH
24	GOVERNOR BOX	47	BATTERY PACK

EN090527-1