

# GS8212B

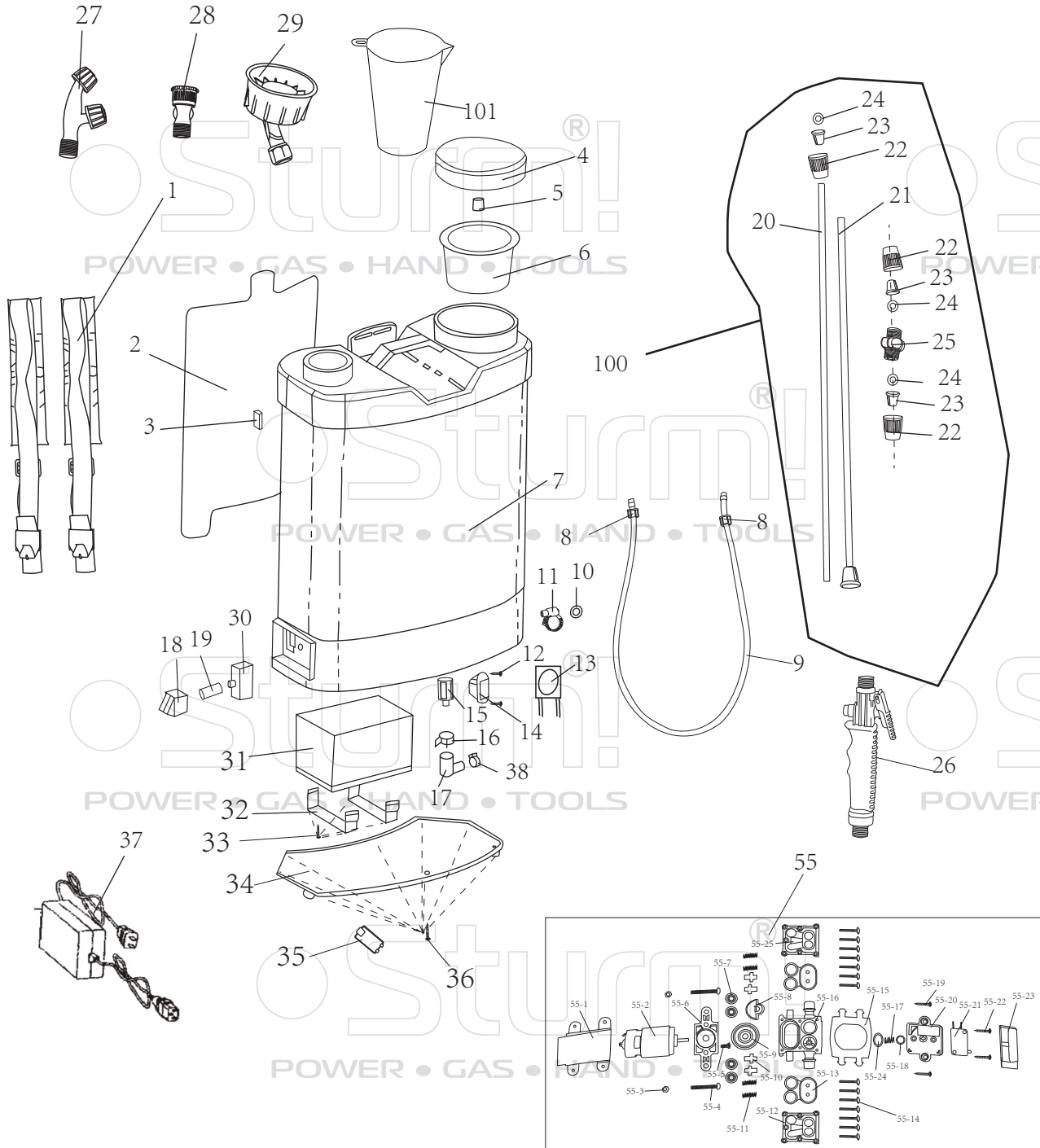

NO.	DESCRIPTION	NO.	DESCRIPTION
1	Straps	33	Screw
2	Back pad	34	Base plate
3	Fixed bracket	35	Base plate buckle
4	cap	36	Screw
5	Intake valve	37	charger
6	Filter	38	Clamp
7	Tank	55-1	housing
8	Hose nut	55-2	Dc motor
9	Hose	55-3	nut
10	Rubber ring	55-4	Screw
11	Tube clamp	55-5	Screw
12	Screw	55-6	Support bracket
13	Power indicator	55-7	Valve seat
14	Charger plug	55-8	Eccentric wheel
15	Filter	55-9	bearing
16	Clamp	55-10	valve core
17	Water inlet connection	55-11	Spring
18	Switch	55-12	Pump body cover
19	Speed control knob	55-13	Pump membrane
20	Stainless steel pipe 1	55-14	Screw
21	Stainless steel pipe 2	55-15	connection rod
22	nut for spray rod	55-16	Pump body
23	cover for opening	55-17	Spring
24	seal ring	55-18	spacer
25	Spray rod joint	55-19	Screw
26	Trigger	55-20	Pump body roof
27	double nozzle	55-21	Switch
28	Four- hole nozzle	55-22	Screw
29	eight- hole nozzle	55-23	Switch cover
30	Speed-control switch	55-24	Rubber ring
31	12V,8AH Battery	55-25	Pump body under cover
32	Battery belt	100	spray gun assembly
101	Measuring cup		

UK-ST20200807